

# ECOFLOW

## User Manual

### EcoFlow RIVER Pro

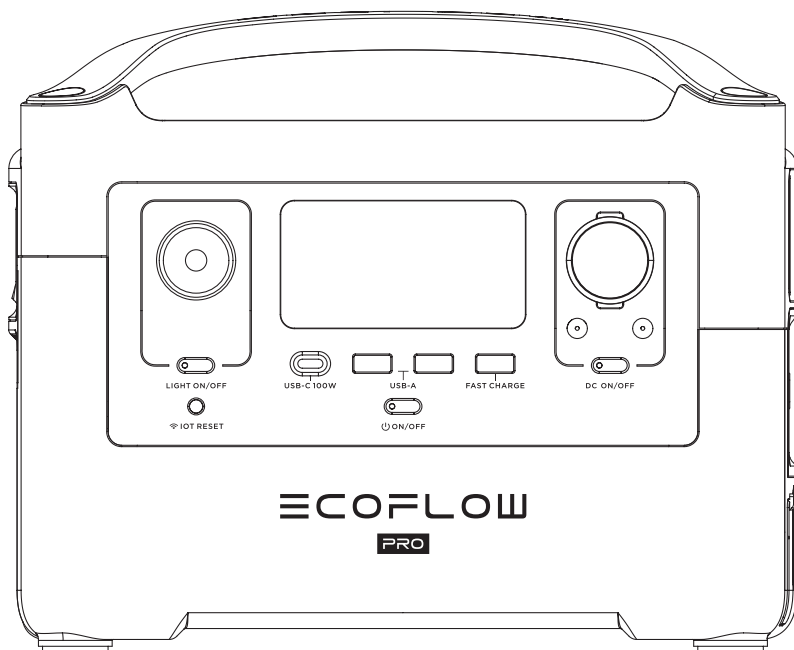

**WARNING**

1. Keep EcoFlow™ RIVER Pro ("RIVER Pro") and the accessories dry and DO NOT expose the product and accessories to high heat.
2. Never disassemble, puncture, shock, crash, or incinerate the product.
3. Recycle and dispose of RIVER Pro in accordance with the local regulations.
4. Pay attention to safety when handling the RIVER Pro.
5. Children or people with disabilities should use the RIVER Pro under adult supervision.

**Contact us:**  
[www.ecoflow.com](http://www.ecoflow.com)

# Glossary

The following terms are used in this document to indicate various levels of potential harm that may be caused by improper operation.

## NOTICE

The instructions, if not properly followed, may result in property damage and minor physical damage.

## CAUTION

The instructions, if not properly followed, may result in property damage and serious physical damage.

## WARNING

The instructions, if not properly followed, may result in property damage, major accident and serious injury.

### WARNING

Read the **ENTIRE User Manual** before operating. Failure to operate the product correctly may result in damage to the product or personal property and cause serious injury. EcoFlow will not assume any legal responsibility. **DO NOT** use the product with incompatible components or alter the product in any way without following the instructions provided by EcoFlow. Otherwise, you cannot get after-sales service from EcoFlow under warranty condition. These Safety Guidelines include instructions for safety, operation and maintenance. It is important to read and follow all the instructions and warnings in the user manual before assembly, setup or use.

# Product Safety Guidelines

### WARNING

Improper use may result in fire, property damage or personal injury. Make sure to use the product according to the following safety rules and guidelines.

## Product Disclaimer

Read all safety tips, warning messages, terms of use and disclaimers carefully. Refer to the terms of use and disclaimer at <https://ecoflow.com/pages/terms-of-use> and stickers on the product before use. Users take full responsibility for all usage and operations. Familiarize yourself with the related regulations in your area. You are solely responsible for being aware of all relevant regulations and using EcoFlow products in a way that is compliant.

## Product Use:

1. DO NOT expose the product to any liquids. Do not immerse the product in water. DO NOT leave the batteries out in the rain or near a source of moisture. Moisture in the RIVER Pro could cause short circuits, component failure, fires or even explosions.
2. Never use NON-EcoFlow parts. Go to <http://www.EcoFlow.com> to purchase new parts. EcoFlow takes no responsibilities for any damages caused by the use of non-EcoFlow parts.
3. Never install or remove other modules from the RIVER Pro when it is turned on. Do Not plug or unplug other modules when the power of the product is turned on, otherwise the power interface may be damaged.
4. Using the product in environments above 140°F (60°C) may cause fire or explosion. Using the product in environments below -4°F (-20°C) will severely affect the performance of the product. Allow the product to return to a normal operating temperature before use.
5. DO NOT use the batteries in strong electrostatic or electromagnetic environments. Otherwise, the battery control board may malfunction and cause a serious accident during use.
6. Never disassemble or puncture the product in any way. Otherwise, it may leak, catch fire, or explode.
7. DO NOT use the product if it was involved in a crash or a suffered a forceful jolt.

8. If the product falls into the water during use, take the product out immediately and put it in a safe and open area. Keep a safe distance from it until it is completely dry. Never use it again and dispose it properly as described in the Battery Disposal section below. If the product catches fire, it is recommended to use fire extinguishing methods in the following order: water or water mists, sand, fire blanket, dry powder fire extinguisher, carbon dioxide fire extinguisher.
9. DO NOT put the product in a microwave oven or in a pressurized container.
10. Do Not allow pins, wires or other metal pieces to insert to the RIVER Pro case, outlets or controls. Metal pieces may short circuit the product.
11. Avoid collision. DO NOT place heavy objects on top of the RIVER Pro.
12. If there is dirt on any plug or outlet surface, use a dry cloth to clean it. Otherwise, it will cause abrasion and result in energy loss or inability to charge.

### Product Charging:

1. Always use EcoFlow approved charging cables. EcoFlow does not take any responsibilities for any damages caused by using non-EcoFlow charging cables.
2. DO NOT use RIVER series portable power station AC charging cables on DELTA series power stations. EcoFlow takes no responsibilities for any damages caused by customers' failure to follow instructions. Doing so will void the warranty.
3. When charging, please place the RIVER Pro on the ground with no flammable or combustible materials around. To prevent accidents, never leave the RIVER Pro unattended during charging.
4. DO NOT charge the product immediately after a long or heavy load, because the product temperature may have become too high. DO NOT charge the product until it cools down to room temperature.

### Product Storage and Transportation:

1. Keep the RIVER Pro out of the reach of children. If any children accidentally swallow parts, please seek medical attention immediately.
2. If a low-battery warning appears, charge the product before storing it. Otherwise, long-term storage may cause damage to the batteries in the product. Batteries in the product will enter hibernation mode if they are depleted and stored for a long time. Recharging the product can bring the battery out of hibernation.
3. DO NOT place the product near a heat source or under high temperature, such as inside a car in direct sunlight, a fire source, or an operating stove.
4. Store the product in dry environments. Please keep it away from water.
5. Make sure no objects can fall on or around the product while it is being stored.
6. Never ship a product with a battery power level higher than 30%.

### Product Battery Disposal:

1. Dispose of RIVER Pro in specific recycling boxes only after a complete discharge. Batteries are hazardous chemicals. Please strictly follow your local regulations regarding the battery disposal and recycling.
2. Dispose of the product if the power cannot be turned on after over-discharging.

### Product Maintenance:

1. Temperature for normal use and storage of this product is -4°F to 113°F (-20°C to 45°C) and temperature for optimal use and storage of this product is 68°F to 77°F (20°C to 25°C).
2. If the product is not used for a long time, the battery life may be reduced.
3. Discharge RIVER Pro to 30%, then charge to 85% every 3 months to keep the battery healthy.

### Travel Notice:

Do Not bring RIVER Pro on flights.

## RIVER Pro Use Care and Safety Guide

### CONGRATULATIONS!

You are now an EcoFlow RIVER Pro user. This brief pamphlet is meant to help you. Please take some time to read it carefully before using the product.



## NOTICE

To turn RIVER Pro on or off, you need to PRESS and HOLD the ON/OFF system Power Button. To turn on the AC power outlet, you need to PRESS and HOLD the AC Power Button after turning on RIVER Pro. We set the AC power button for users to turn off AC power when they don't need it and save power. Please follow this introduction step-by-step to be familiar with each of RIVER Pro's ports, buttons, display screens and more. Please fully charge (100%) your RIVER Pro before use it.

## FCC Statement:

This product complies with Part 15 of the FCC Rules. Operation is subject to the following two conditions:

- (1) This product may not cause harmful interference, and
- (2) This product must accept any interference received, including interference that may cause undesired operation.



## WARNING

Changes or modifications not expressly approved by the party responsible for compliance could void the user's authority to operate the equipment.



## NOTICE

This equipment has been tested and found to comply with the limits for a Class B digital device, pursuant to Part 15 of the FCC Rules. These limits are designed to provide reasonable protection against harmful interference in a residential installation. This equipment generates uses and can radiate radio frequency energy and, if not installed and used in accordance with the instructions, may cause harmful interference to radio communications. However, there is no guarantee that interference will not occur in a particular installation. If this equipment does cause harmful interference to radio or television reception, which can be determined by turning the equipment off and on, the user is encouraged to try to correct the interference by one or more of the following measures:

1. Orient or relocate the receiving antenna.
2. Increase the separation between the equipment and receiver.
3. Connect the equipment into an outlet on a circuit different from that to which the receiver is connected.
4. Consult the dealer or an experienced radio/TV technician for help.

## FCC Radiation Exposure Statement:

This equipment complies with FCC radiation exposure limits set forth for an uncontrolled environment. This equipment should be installed and operated with minimum distance 20cm between the radiator & your body.

# CONTENTS

EcoFlow App Download Guide	1
Features of the RIVER Pro	2
LCD Display Introduction	4
Solar Panel Connection	8
Entry-Level UPS	9
AC X-Boost Mode	10
RIVER Pro and RIVER Pro Extra Battery Connection	11
Technical Specifications	12
How to Recharge RIVER Pro	13
FAQs	14
What's in the Box	14

# EcoFlow App Download Guide

## 1. Download the EcoFlow App

- Search “EcoFlow” in the Google Play Store or App Store to download the App.  
You may also use your mobile phone to scan this QR code or enter the download link in your browser:

<https://ecoflow.com/pages/ecoflow-app>

**2. For more information about the App, please follow the instruction on the App or our official website [www.ecoflow.com](http://www.ecoflow.com).**



## Privacy Policy

By using EcoFlow Products, Applications and Services, you consent to the EcoFlow Term of Use and Privacy Policy, which you can access via the “About” section of the “User” page on the EcoFlow App or on EcoFlow Official website at <https://ecoflow.com/pages/terms-of-use> and <https://ecoflow.com/pages/privacy-policy> .

# Features of the RIVER Pro

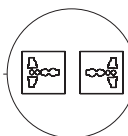
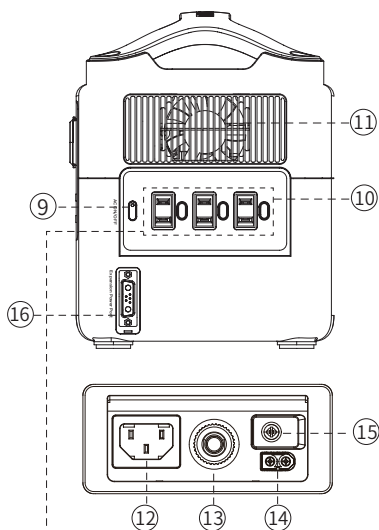
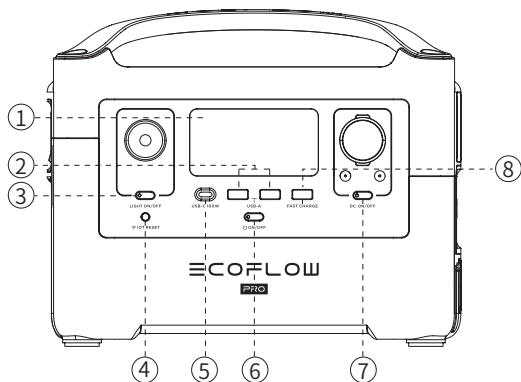

## 220-240V region\* Dedicated AC Output

\*EcoFlow has designed different AC output sockets following the local regulations of different countries.

1. LCD Display

2. USB-A Output Ports

3. ON/OFF Button of LED Light

4. IOT Reset Button

(PRESS & HOLD 3s to reset Wi-Fi)

5. USB-C 100W Output Port

6. Power Button & LCD Display Screen

ON/OFF & Display Screen Power Indicator

7. DC Output ON/OFF Button (Car Outlet, 2 DC 5521 Output Ports) & DC Output Indicator

8. Fast Charge USB-A Output Port

9. AC Power Button (PRESS for ON/OFF) & AC Output Indicator

10. 3 AC Output Sockets (100-120V)  
2 AC Output Sockets (220-240V)

11. Ventilation Fan

12. X-Stream Charging Input Port

13. Overload Protection Switch

14. Solar Charge/Car Charge Input Port

15. Power Earth Screw

16. Expansion Power Port

## 1. LCD Display

Displays various conditions of the product.

## 2. USB-A Output Ports

Charge a wide array of devices such as smart phones, tablet, GoPro, speakers, or anything else that could be charged through USB-A Port. The USB-A output icon will appear on the LCD display when a USB-A port is in use.

### **3. ON/OFF Button of LED Light**

There're three types of LED light: low light, strong light, and SOS rescue signal flash. Press it once to turn on the low light; press it twice to turn on the strong light; press it one more time to turn on the SOS rescue signal flash; then press it again to turn off the LED light. Long press can turn off the LED directly.

### **4. IOT Reset Button (PRESS & HOLD 3s to reset Wi-Fi)**

When you first use IOT function or you are changing the network environment, you need to press and hold IOT Reset button for 3 seconds to reset the Wi-Fi. It can connect with the mobile phone, then reconfigure the wireless network through the APP. When using the IOT mode, make sure the power station has sufficient amount of power or is connected to a power source to keep IOT standby.

### **5. USB-C 100W Output Port**

Devices that charge through a USB-C port, such as a MacBook Pro, Android phone, can be charged by the RIVER Pro USB-C port. The USB-C Output icon will appear on LCD Display when the USB-C port is in use.

### **6. Power Button & LCD Display Screen ON/OFF Power Indicator**

Press the system power button once to turn the RIVER Pro on. Press and hold the system power button to turn the RIVER Pro off. When RIVER Pro is turned on, the power indicator is in breathing mode, and the display is on; When the RIVER Pro is running, you can switch on or off the display screen by pressing the Power Button once. When RIVER Pro senses that any output port is in use, the display will automatically light up. The RIVER Pro screen will enter into the sleep mode after being in idle for more than 5 minutes, but the battery will still be running. The system standby time is 2 hours by default. You can set up the system standby time and screen standby time via the App.

### **7. DC Output Port (Car Outlet, 2 DC 5521 Output Ports) & DC Output Indicator**

Press DC ON/OFF to turn on or off RIVER Pro DC power. The DC power button controls the RIVER Pro's car charger output and two direct currents (DC 5521) outputs. The car charger output supports an output up to 10A, which is sufficient to power most electrical appliances used in vehicles. When the DC ON/OFF switch is on, the product will not shut down on its own until it runs out of power.

### **8. Fast Charge USB-A Output Port**

The USB-A output icon will appear on the LCD display when the port is in use. Fast charge-enabled devices can be charged at a maximum speed of 28W. If your device does not support fast charging, the device will charge in a normal speed.

### **9. AC Power Button AC Output Indicator**

The AC power button controls the AC output of the RIVER Pro. The AC power needs to be turned on manually. To enable AC power, press the AC power button. When AC power is not in use to charge a device, press the AC power button to turn off the AC power. Make sure to unplug the power cord from the AC port. When the AC power of the RIVER Pro is enabled, the AC indicator will light up. If the AC power is not used for more than 12 hours, the AC ports will turn off automatically.

### **10. 3 AC Output Sockets (100-120V) / 2 AC Output Sockets (220-240V)**

Charge devices that require a 220-240V (220-240V region)/100-120V (100-120V region) wall charger such as laptops, TVs, refrigerators, vacuums, etc. The X-Boost feature enables the built-in 600W inverter to support 600W to 1200W devices by lowering their power required. This feature does not support all electrical devices with higher power rating, please test to confirm before use. It is not recommended to use the RIVER Pro to power heavy-duty devices e.g., air conditioners, coffee machines, clothes dryer, electric camp stoves, full size refrigerators, microwaves, mowers, ovens, washing machines etc.

### **11. Ventilation Fan**

The fan prevents RIVER Pro from overheating. Please make sure nothing blocks the vents at both ends of the RIVER Pro.



## 12. X-Stream Charging Input Port

Plug in the AC Charging Cable into the port and connect the AC Charging Cable to an AC power source. The U.S. and Japanese version support 100Vac-120Vac (50Hz/60Hz) / international version supports 220Vac-240Vac (50Hz/60Hz) charging.

## 13. Overload Protection Switch

When the input current continuously exceeds 10A during a charge, the AC charging port will trigger the overload protection (the Overload Protection Switch button will automatically pop out). When the product is confirmed to be normal, press the overload protection switch button to continue charging.

## 14. Solar Charge/Car Charge Input Port

Connect at most two 110W solar panels in parallel to recharge RIVER Pro. RIVER Pro supports a solar input of 10-25V, 200W, 12A Max. RIVER Pro supports 12V car charge up to 8A. (Remember to start the engine when you charge via car charge, otherwise, the car battery may be drained.) Do not use the same cigarette lighter port to charge other devices when recharging RIVER Pro. The RIVER Pro outlets can still be used to charge your devices when the RIVER Pro is recharging via car charge.

## 15. Power Earth Screw

For safety reasons, some electrical appliances need to be grounded. The power earth screw provides an option to get your RIVER Pro grounded using a grounding cable.

## 16. Expansion Power Port

Plug in the Expansion Power Cable into this port to connect your RIVER Pro to a RIVER Pro Extra Battery to expand the battery capacity to 1440Wh.

## LCD Display

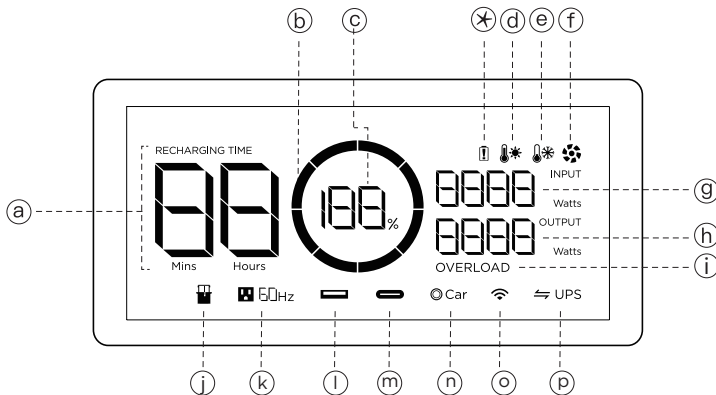

## a. Remaining Charge/Discharge Time

The number indicates the remaining charge/discharge time (in minutes) for RIVER Pro.

## b. Battery Level Indicator

Shows the remaining power. The icon rotates while charging. If the remaining power is equal to 0%, the icon will flash to indicate a low battery warning. In this case, recharge the product.

## c. Battery Level Percentage

Shows the percentage of the power. If it displays 0%, please charge RIVER Pro immediately.

## d. High Temperature Indicator

When the temperature of the RIVER Pro is too high, a high-temperature warning icon appears on the screen to warn that the temperature of the product is too high. Please cool down the product.

## e. Low Temperature Indicator

When the temperature of the RIVER Pro is too low, a low-temperature warning icon appears on the screen to warn that the temperature of the product is too low. Please warm up the product properly before use.

## f. Fan Indicator

The RIVER Pro fan speed is intelligently controlled by the RIVER Pro, and the displayed speed is related to the fan speed.

## g. Current Input

Shows the current input power of RIVER Pro in watts.

## h. Current Output

Shows the current output power of RIVER Pro in watts.







## i. Overload Warning

The overload icon appears along with a second icon indicating what part of the RIVER Pro is in an overload condition.

## ✕. Battery Indicator











Refers to the battery





## Port Usage Indicators

j	<b>Extra Battery Indicator</b> 	The Extra Battery icon will appear when Extra Battery is connected to the main model.
k	<b>AC Indicator</b> 	The AC indicator icon will appear when the AC power button is turned on.
l	<b>USB-A Indicator</b> 	The USB-A output icon will appear on the LCD display when a USB-A port is in use.
m	<b>USB-C Indicator</b> 	The USB-C output icon will appear on the LCD display when a USB-C port is in use.
n	<b>Car Power Output Indicator</b> 	The Car Power Output icon will appear on the LCD display when a Car Output port is in use.
o	<b>IOT Indicator</b> 	The icon will appear when the unit is connected to the App.
p	<b>UPS Indicator</b> 	When the SOC (State of Charge) is set in the EcoFlow App, the UPS icon will appear on the screen.

## Protection Information Instruction

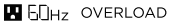
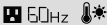
The RIVER Pro display screen uses different icons and combined icons to indicate the reason for protection.

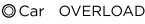
 OVERLOAD	<b>USB-A Overload Protection</b>	USB-A and OVERLOAD icons flash together. Disconnect all electrical appliances and wait 10 seconds before adding each appliance back.
	<b>USB-C High Temperature Protection</b>	USB-C and High-Temperature icons flash together. Disconnect electrical appliance and let RIVER Pro cool down before adding appliance back.
 OVERLOAD	<b>USB-C Overload Protection</b>	USB-C icon and the OVERLOAD icon flash together. Disconnect electrical appliance and wait 10 seconds before adding appliance back.
RECHARGING TIME 	<b>High Temperature Recharge-protection</b>	RECHARGING TIME, Exclamation and High-Temperature icons flash together. This will happen especially when you recharge the RIVER Pro immediately after a heavy battery use. Disconnect Charging Cables and all electrical appliances and wait until RIVER Pro has cooled down before plugging Charging Cable back in and recharging.
	<b>High Temperature Discharge-protection</b>	Exclamation and High-temperature icons flash together. Turn OFF System Power and let RIVER Pro cool down before turning the System Power back on.
RECHARGING TIME 	<b>Low Temperature Recharging-protection</b>	Recharging Time, Exclamation and Low-Temperature icons flash together. Disconnect Charging Cables and all electrical appliances and place RIVER Pro in warmer place before plugging Charging Cable back in and recharging.
	<b>Low Temperature Discharge-protection</b>	Exclamation and Low-Temperature icons flash together. Turn OFF System Power and place RIVER Pro in warmer place before turning the System Power back on
RECHARGING TIME  OVERLOAD	<b>Overload Recharging-protection</b>	RECHARGING TIME, Exclamation and OVERLOAD icons flash together. Unplug Charging Cables, restart RIVER Pro and plug back in.
 OVERLOAD	<b>Overload Discharging-protection</b>	Exclamation and Overload icons flash together. Disconnect all electrical appliances, restart RIVER Pro, and add each appliance back in in turn. Please note that electrical appliances must be operated within rated power.
 - - - -	<b>Communication Failure between Main Board and BMS</b>	Only the Exclamation icon is flashing. Restart RIVER Pro.
	<b>Light stays on</b>	The Exclamation icon is on. Restart RIVER Pro.

	<b>Communication Failure between Main Board and AC</b>	AC icon Flashes. Restart RIVER Pro.
	<b>Inverter Output Overload</b>	AC and Overload icons flash together. Turn off RIVER Pro. Unplug all appliances. Wait 10 seconds, turn System Power ON then AC Power ON and plug each appliance back in in turn. If the icons keep flashing, do not charge or discharge the unit. Please note that electrical appliances must be operated within rated power. (For more information about X-Boost function, go to P10.
	<b>Inverter High Temperature Protection</b>	AC and High-temperature icons flash together. Turn off RIVER Pro and let it cool down. Then turn System Power On and AC Power On.
	<b>Inverter Low Temperature Protection</b>	The AC and Low-Temperature icons flash together. Turn off RIVER Pro, move RIVER Pro to a warmer place and wait for the inverter to warm up. Then turn System Power On and AC Power On.
	<b>Fan Blockage</b>	Fan icon flashes. Turn Off RIVER Pro and carefully clean and vacuum around vents at both sides of the RIVER Pro. Turn System Power On.
	<b>Car Charger Overload</b>	Car and OVERLOAD icons flash together. Restart RIVER Pro, and make sure that electrical appliances must be operated within rated power.
	<b>Car Charger High Temperature Protection</b>	Car and High-Temperature icons flash together. Turn RIVER Pro off and let it cool down. Turn System Power On then DC Power On.

\*If the product is not operating properly or the icon keep flashing, please contact the customer support team. Do not charge the unit.

# Solar Panel Connection

## How to recharge the RIVER Pro using solar panels?

If you need to know more about the connection of solar panel, please refer to the Solar Panel User Guide. Here we focus on demonstrate how to connect RIVER Pro to 1 set of solar panel or connect RIVER Pro to 2 sets of solar panels in parallel. The RIVER Pro can support a 10-25V DC input. When the input exceeds 25V, the RIVER Pro's overvoltage protection will be triggered. Overvoltage may damage the product. Users should follow these instructions. EcoFlow DO NOT provide free repair services for any product damage caused by connecting too many solar panels to the product or incorrect connection, even during the warranty period.

### 1. Recommend Charging Method

Users can connect a solar panel (**do not connect more than one in series**) as shown in Example 1. Connect the solar panel to the MC4 to XT60 Solar Charging Cable. Connect the XT60 connector to the RIVER Pro's XT60 input to charge the RIVER Pro. Users can connect up to 2 sets of solar panels in parallel to the MC4 port as shown in Example 2. If you want to connect 2 sets of solar panels, And connect them with our solar MC4 parallel connection cable. Connect the XT60 connector to the RIVER Pro's XT60 input to charge the RIVER Pro. The parallel connection cable is an optional accessory that is sold separately.

#### e.g.1

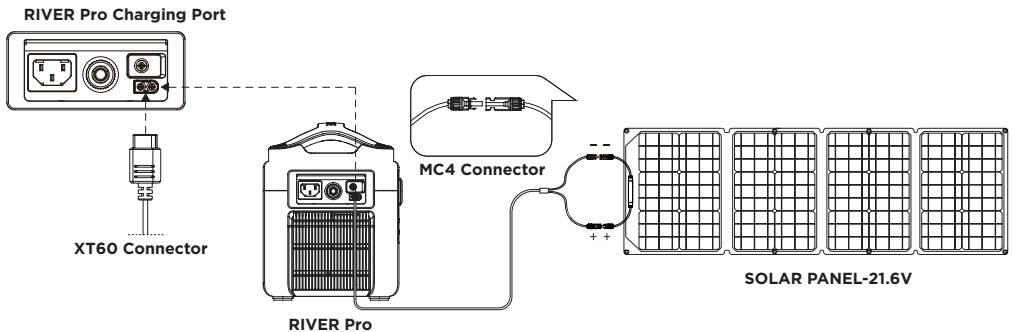

#### e.g.2(Only supports parallel connection, NOT serial connection)

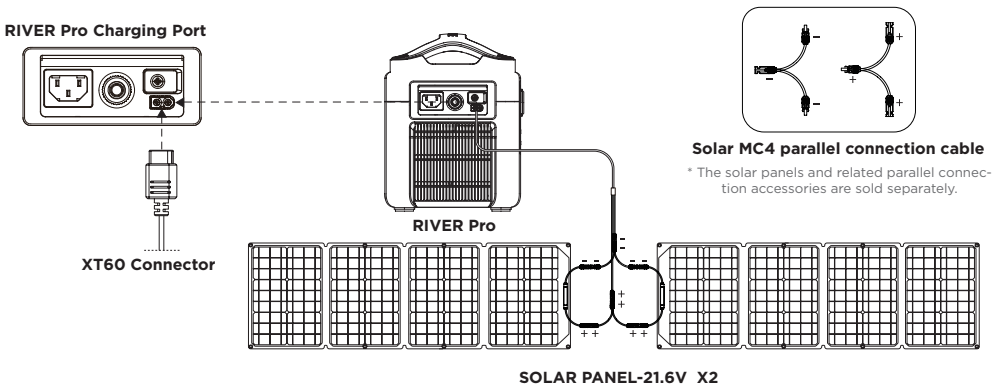

## 2. RIVER Pro supports the use of third-party solar panels (DIY solution)

Users can buy universal solar panels of MC4 connection standard on their own to power RIVER Pro, as long as the voltage and current (10-25V DC, 12A Max) comply with the specifications of RIVER Pro, the panels will be able to recharge RIVER Pro through the MC4 to XT60 conversion cable. However, EcoFlow do not provide free repair services for any damages to the product caused by the quality issue or improper operation of the third-party solar panels, even in the warranty period.

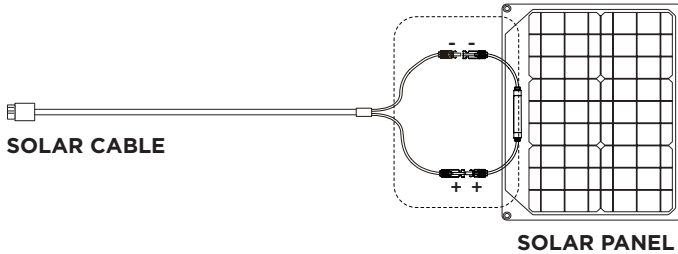

## Entry-Level UPS

### RIVER Pro Entry-level UPS Use Reminder

RIVER Pro's X-Stream system supports an entry-level UPS function. User can use the RIVER Pro AC socket while the RIVER Pro is connected to an AC power source (your devices or appliances connected the RIVER Pro AC socket will get power from the AC power source, not the RIVER Pro battery). When the AC power source loses power suddenly, the RIVER Pro will switch to provide power to the devices and appliances connected to it in <30ms. This is considered as an "entry-level" grade UPS function that does not support 0ms switching. Do NOT connect devices with strict uninterrupted power supply requirements. Perform multiple tests to confirm compatibility before connecting devices such as data servers and workstations with RIVER Pro. EcoFlow will not be responsible for any loss of data or equipment damages caused by customers' failure in following the instruction. In accordance with the UL2743 standard, the AC outlets of the RIVER Pro are in a double blade, ungrounded configuration, it is recommended to use the UPS function only for temporary emergency usage rather than for long-term usage. DO NOT connect the RIVER Pro to devices or electrical appliances with bare metal when charging to avoid the risk of electric shock.

### Entry-Level UPS User Guide

Users can connect the AC Charging Cable of RIVER Pro to an AC power source and connect a device to RIVER Pro and turn on the AC Power Button to automatically enter the entry-level UPS mode. When the AC power source is cut off, power will be supplied from the battery of RIVER Pro to your device (as shown below).

**\* UPS is only applicable to electrical appliances below 600W. To avoid an Overload condition, do not attempt to power any equipment drawing more than 600W of power. EcoFlow will not be responsible for any loss of data or equipment damages caused by careless use or customers' failure to follow the instructions. Only one RIVER Pro can conduct the UPS function; the UPS function is not available when more than one RIVER Pro is connected together. Please follow the connection instructions below:**

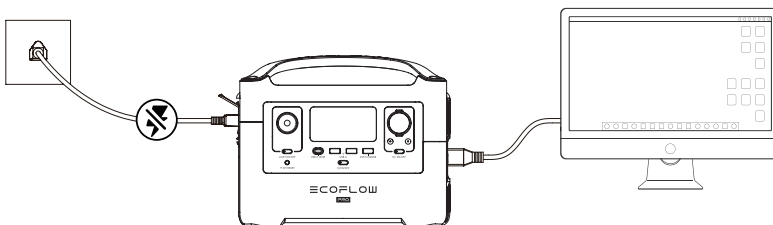

## AC X-Boost Mode

With the built-in 600W inverter, you can use the X-Boost feature to power 600W-1200W appliances without the disruption caused by overload protection. Traditional inverters will overload when one electrical appliance with a higher rated power is connected. Meanwhile, RIVER Pro's built-in inverter, which has the X-Boost feature, enables the powering of 600W-1200W electrical appliances. Please take note of the following when using this mode:

- 1. The X-Boost mode is enabled by default. You can use the EcoFlow app to turn this function on/off.**
- 2. The X-Boost mode is not available in the following situations: the charging state and X-Boost mode off state.**
- 3. When using appliances with a rated power of 600W-1200W, please connect only one appliance. When connecting more than one electrical appliance, the change of voltage may affect the usage of other electrical appliances. \***

**\* You may use electrical appliance with heating elements and a rated power between 600W-1200W, such as hair dryers and electric kettles. But the X-Boost mode is not suitable for all electrical appliances.**

**Some appliances with a rated power of 600W-1200W that have strict voltage requirements are still not compatible. Please conduct a full test to confirm before usage.**

**It is not recommended to use the RIVER Pro to charge heavy-duty devices, such as air conditioners, coffee machines, clothes dryer, electric camp stoves, full size refrigerators, microwaves, mowers, ovens, washing machines etc.**

# RIVER Pro and RIVER Pro Extra Battery Connection

Get the RIVER Pro, RIVER Pro Extra Battery and Expansion Power Cable ready. Power off both the RIVER Pro and RIVER Pro Extra Battery before attempting to connect them together. If the products are not turned off, they cannot be successfully connected. Then follow the steps below.

1. Open the Expansion Port cover below the AC port of the RIVER Pro to access the Expansion Power Port. Connect the Expansion Power Cable to the port. Tighten the screws on both sides of the port to secure the connection.
2. Open the Expansion Port cover of the RIVER Pro Extra Battery to access the Expansion Power Port. Connect the free end of the Expansion Power Cable to the RIVER Pro Extra Battery Expansion Power Port. Tighten the screws on both sides of the port to secure the connection.
3. Turn on the power button of the RIVER Pro or RIVER Pro Extra Battery. If the display of the RIVER Pro shows the extra battery icon, the connection is successful. Fully charge the products for the first time and ensure the voltage is consistent to maximize the performance.

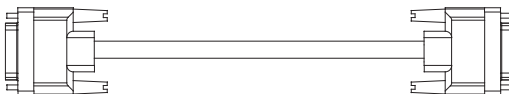
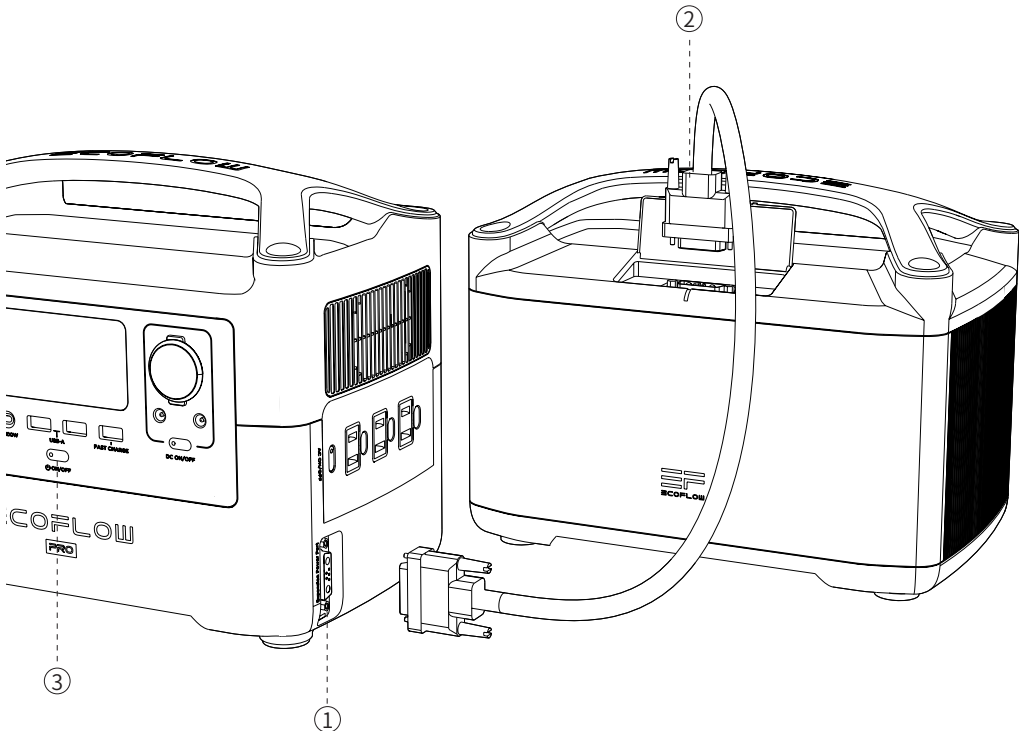

## Expansion Power Cable

\* Not included in the package, this cable only comes with RIVER Pro Extra Battery



# Technical Specifications

## General Specs

Net Weight	* 16.8 lbs (7.6kg)
Dimensions	* 11.4 x 7.1 x 9.3 in (28.9 x 18.0 x 23.5 cm)
Capacity	720Wh (28.8V)
Testing and certification	UL Standard, CE, FCC, RoHS, RCM

## Outputs

AC Output (x3) / (x2 International Version) Full Sine Wave	600W (Surge 1200W) total, 120Vac (50Hz/60Hz) / 230Vac (50Hz/60Hz)
USB-A Output (x2)	5Vdc, 2.4A, 12W Max, per port
USB-A Fast Charge (x1)	5Vdc, 9Vdc, 12Vdc, 2.4A, 28W Max
USB-C Output (x1)	5Vdc, 9Vdc, 12Vdc, 15Vdc 20Vdc, 5A, 100W Max
Car Power Output (x1)	136W, 13.6Vdc, 10A Max
DC5521 Output (x2)	13.6Vdc, 3A Max (per port)

## Input

AC Charge Input Voltage	100-120Vac (50Hz/60Hz) International Version 220-240Vac (50Hz/60Hz)
AC Charge Input Power (Example 1)	X-Stream Charge 660W Max
Solar Charge Input	200W 10-25Vdc 12A Max
Car Charger (Example 2)	12Vdc 8A Max

## Battery

Cell Chemistry	Lithium-ion
Discharge Temperature	-4°F to 140°F (±5°F), -20°C to 60°C (±3°C)
Charge Temperature	32°F to 113°F (±5°F), 0 to 45°C (±3°C)
Shelf Life	1 Year (after fully charged)
Cycle Life	800 cycles to 80%+ capacity

\* Please Note: The above weight, size, etc. have certain measurement errors. Please refer to the actual measurement.

# How to Recharge RIVER Pro

## Example 1:

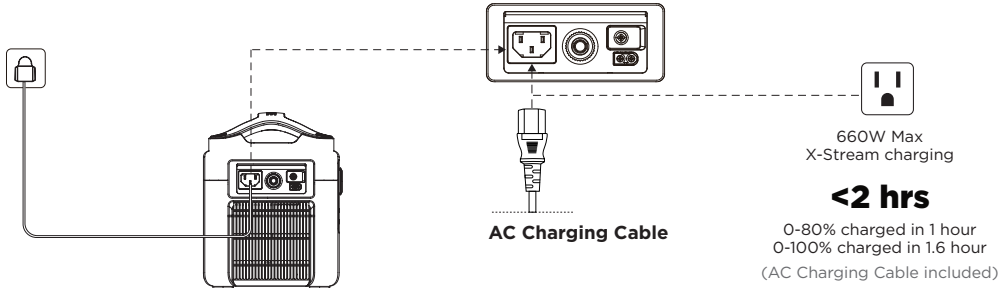

## Example 2:

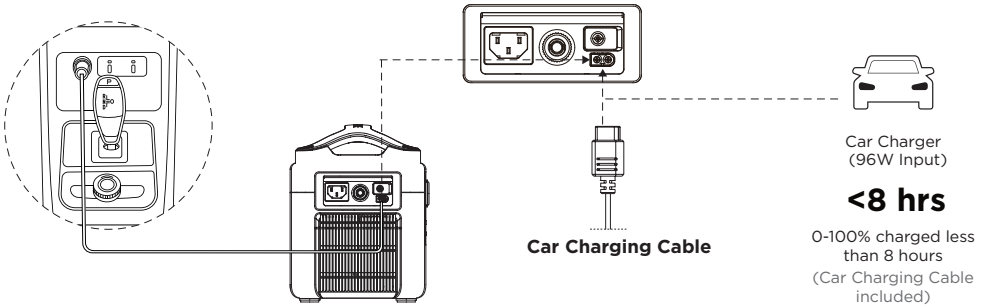

## How do I recharge my RIVER Pro?

RIVER Pro has an AC charging port and an XT60 charging port located on the side. The RIVER Pro can be charged via AC power, 12V car charger or solar panels.

## Can RIVER Pro power my devices while it's charging?

Yes, RIVER Pro can output power while being charged.

## FAQs

### How do I clean RIVER Pro?

The RIVER Pro is a versatile tool on many adventures, simple cleaning will likely be required from time to time. Use dry, non-abrasive cloths to wipe. If you need to clean more thoroughly, we recommend that you use detergent that is used for cleaning mobile phones and computer screens. DO NOT expose RIVER Pro to large amount of liquid.

## How do I store RIVER Pro?

Please store RIVER Pro in a dry and cool place. DO NOT place it near water. Please turn off the RIVER Pro and store it within its recommended use and storage temperature range. If you need to store the RIVER Pro for a long time, please discharge the RIVER Pro to 30%, then charge it to 85% every 3 months.

## How do I use RIVER Pro safely?

Please use RIVER Pro within its recommended operating temperature range. Using RIVER Pro out of the recommended operating temperature range may cause RIVER Pro to exceed its safe and effective working limits. RIVER Pro is not waterproof. DO NOT immerse RIVER Pro in water. Doing so will void the warranty. If RIVER Pro power electrical devices with heating elements (600W) for over a half hour, it is normal to see the high-temperature protection icon. Please wait for about 1 hour before charging the River Pro, or using it to power devices again.

## Can it be upgraded?

The firmware can be upgraded using the EcoFlow App. Turn on the RIVER Pro before firmware upgrade. It is recommended that the RIVER Pro is connected to an AC power source or has about 50% battery level when upgrading. Please do not use RIVER Pro to recharge your appliances and devices during firmware upgrade. For more details, please refer to “How to upgrade firmware” FAQ in the EcoFlow App.

## What's in the Box



**RIVER Pro**

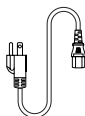

**AC Charging Cable  
(Input)**

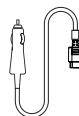

**Car Charging Cable  
(Input)**

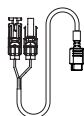

**Solar Charging Cable  
(MC4 to XT60 Input)**

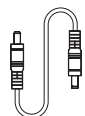

**DC5521-DC5525  
Cable**



**User Manual and  
Warranty Card**

EcoFlow™ is a trademark of Shenzhen EcoFlow Technology Limited (abbreviated as “EcoFlow”) and its affiliated companies.